

The AIO Solution

- > Allows precise and reproducible immobilization of all the body regions
- > High level of patient comfort
- > Reduction of patient set-up time
- > Ease of use
- > Good dosimetric properties

The AIO Solution[®] All-in-One patient positioning system

created by Dr. Kati Hideghéty

The reproducibility and stability of patient positioning is extremely important for a precise radiation therapy treatment. The position of the tumour in space is a dynamic element that is difficult to keep under control during the actual treatment delivery. Therefore, potential changes in the position of the patient should be limited to a minimum. The AIO Solution makes this possible by immobilizing patients in a precise, reproducible and yet comfortable way. The AIO Solution facilitates and refines treatments. With one base plate and different sets of cushions and thermoplastic masks, all parts of the body are positioned and immobilized in a comfortable, exact and reproducible way.

These refined immobilization techniques allow IMRT and IGRT procedures in almost any anatomical location, including breast and lung.

Meeting the highest demands in radiation oncology...

- > Exact reproducibility of the patient's position in imaging and therapy.
- > Highest degree of patient comfort for IMRT and IGRT procedures.
- > Precise immobilization of all body regions.
- > Increased certainty of location of external and internal anatomical structures.
- > Reduced inter- and intra-fraction variations.
- > Reduced daily positioning uncertainties.
- > Reduced patient set-up time.
- > Increased ease of use.

... The AIO Solution fulfils all these requirements.

The AIO Solution contains a cushion set for each anatomical region

- > Brain, head and neck
- > Thorax and abdomen in supine position
- > Prone breast position
- > Belly and pelvis in supine and in prone position



AIO head and neck applications



AIO breast- and lungboard

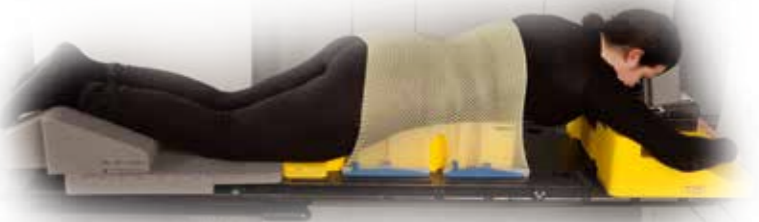

AIO prone breastboard

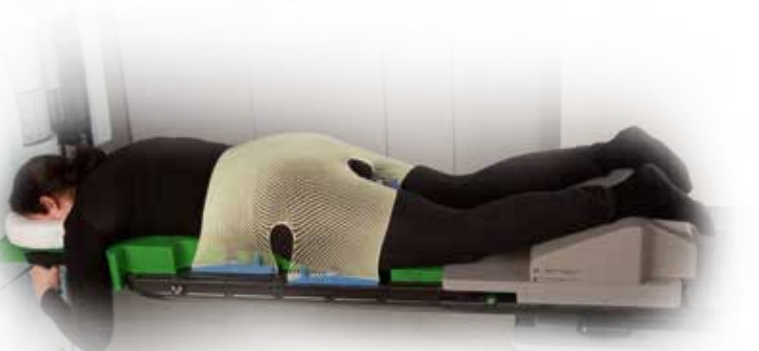

AIO belly- and pelvicboard

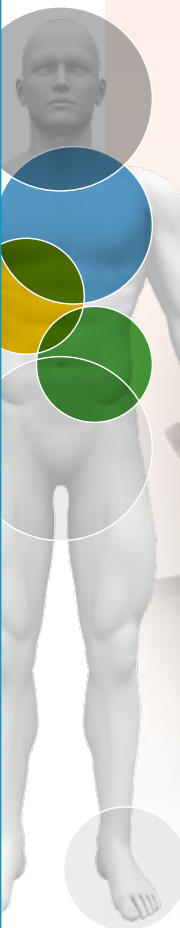

All cushions are easily positioned on the base plate in an indexed way. The cushions have a colour code for easy recognition and fast setup of the system:

head supports and knee & leg cushions are in grey, thorax/abdomen cushions for supine are in blue, breast in prone position cushions are in yellow and belly/pelvis cushions are in green colour.

The cushions are made of a low density foam with excellent dosimetric properties. They are coated to assure patient comfort and hygiene.

The extra-cranial cushions can be adapted in width to accommodate all patient sizes.

The prone breast cushions can be adapted in height.

Each patient position is reproduced and immobilized by means of an Efficast thermoplastic mask that limits movement of the anatomical area of concern.

The AIO Solution is truly an All-In-One system with a head and neck immobilization system, lungboard, breastboard, abdominal system and belly- and pelvicboard in one single product.

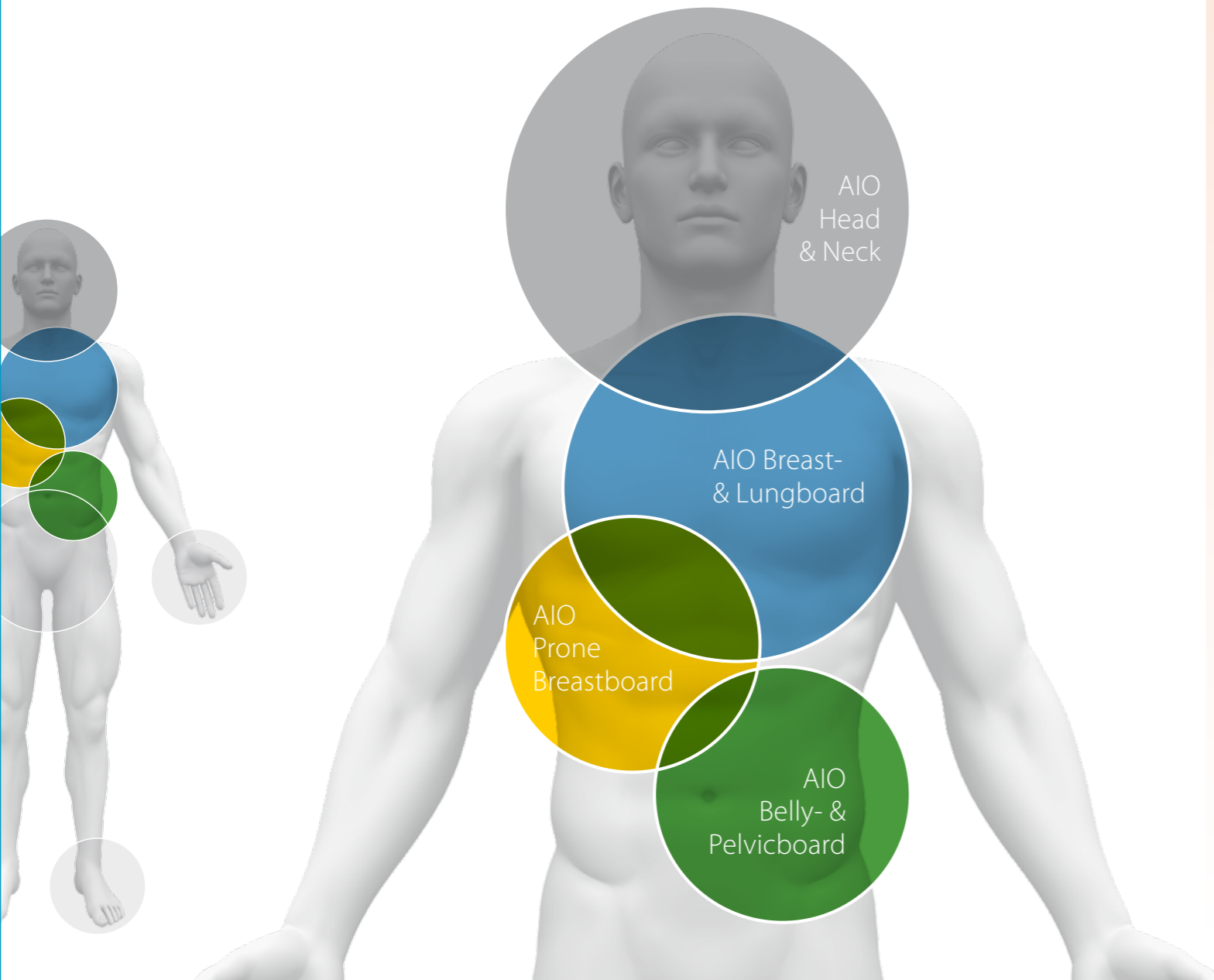

AIO Storage Cabinet

The AIO Storage Cabinet has 5 vertical sliding panels, and can store a complete AIO cushion set, as well as all fixation devices and an AIO board. The panels slide out completely, allowing easy access to the cushions.

The cabinet is designed to efficiently store the AIO Solution components in the simulation or treatment room while taking up limited space (width x depth x height = 1600 x 690 x 1980 mm).

Every AIO part has its own dedicated place so that it can easily be found. This reduces patient set-up time and makes inventory control easy in the event of misplaced parts.

The cabinet is made of laminated pressed wood boards, which are easy to clean. It is easy to assemble, but at the same time sturdy to make it long-lasting. The cushions are stored in such a way that they remain well protected from possible damage.



Art. No. 29100

AIO Head and Neck Applications

The main goal in the positioning of patients with head and neck tumours is a very precise and reproducible positioning and immobilization of the head and upper torso of the patient.
To achieve this, a combination of the AIO hardware and Efficast thermoplastic masks provides an ideal solution.

- > The AIO base plate allows for a reproducible and comfortable positioning of the patient, reducing stress and anxiety.
- > Efficast 3-points masks assure a precise immobilization of the head and 5-points masks of the head, neck and shoulders.

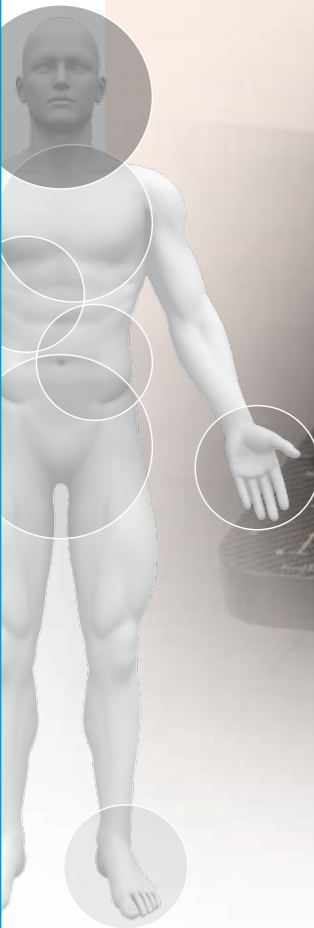

AIO Head and Neck Applications

Head Supports



Art. No. 32704 (set)



Art. No. 32702-MD (set)

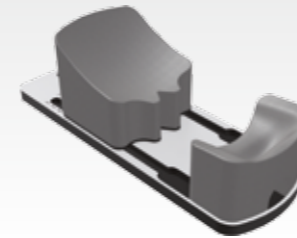

Art. No. 32393

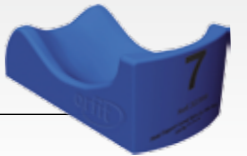

Art. No. 32399-MD

Positioning Blocks and Wedges

Art. No. 32700 (set)

Low density CFL

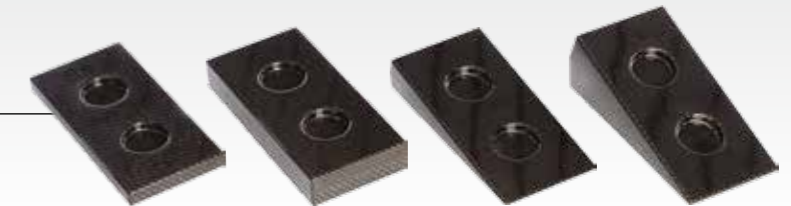

Art. No. 32424

Low density CFL (13,5°C)



Art. No. 35754/8 (set)

High density PE



High Precision Base Plate in CFL or HPL

- > “Long board” base plate for a reproducible positioning of all body regions.
- > Made of a low density carbon fibre laminate sandwich structure with excellent dosimetric properties.
- > This base plate remains on the treatment couch throughout the day, irrespective of the type of radiation treatment.
- > It can be extended over the edge of the couch when using IMRT techniques for a 360° free gantry rotation space around the head and neck area.
- > The plate is colour marked for easy and fast setup of the different cushion sets.
- > Indexing bars can be fitted for indexing vacuum cushions and alpha cradles.
- > The mask fixation slots (for Efficast masks) are identical as in all other Raycast High Precision Base Plates, assuring complete compatibility between all Orfit products.

High Precision Base Plate in CFL and HPL

Art. No. 32301

AIO base plate
Carbon fibre laminate



Art. No. 32204

AIO base plate
High pressure laminate

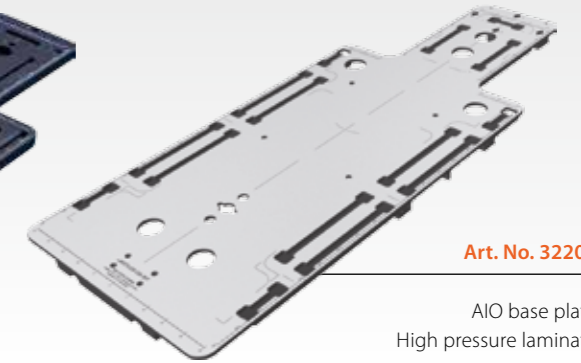

Art. No.	AIO ID	
32301	P-LD	AIO base plate in carbon fibre laminate
32204	P-HD	AIO base plate in high pressure laminate
32301-PED	P-LD	AIO paediatric base plate in carbon fibre laminate
32204-PED	P-HD	AIO paediatric base plate in high pressure laminate
32301/NOLS		AIO base plate in carbon fibre laminate - no leg separator

Art. No. 32204-PED

AIO paediatric base plate
in high pressure laminate



Art. No. 32301-PED

AIO paediatric base plate
in carbon fibre laminate



Art. No. 32301/NOLS

AIO base plate
in carbon fibre laminate
No leg separator



AIO Breast- and Lungboard Solution

This cushion set is designed to achieve a comfortable and reproducible supine position of the patient. This position is primarily used for the treatment of malignancies in the thorax and the abdomen. The set consists of wedges, with different angles to increase patient comfort, and arm rests to allow for a comfortable, but reproducible positioning of the arms above the head and out of the treatment fields. Hand grips and head supports will further help in increasing the precision and in finding the correct patient position.

- > 5°, 10° and 15° angled wedges lift the upper body of the patients and thereby facilitate breathing.
- > The coating of the cushions prevents the patient from sliding down.
- > The armrests (20° and 30° angle) have a flat top to support the total upper arm. This increases the patient's comfort.
- > Lateral insert in the cushions allow the positioning of large patients.
- > Specially developed Efficast masks are used in combination with this set to increase the precision of the treatment.
They effectively immobilize the patient in the treated areas by reducing translational and rotational movements.
- > The indexed head supports position the head in a reproducible way and function as an outstanding reference point for the exact position of the rest of the body.

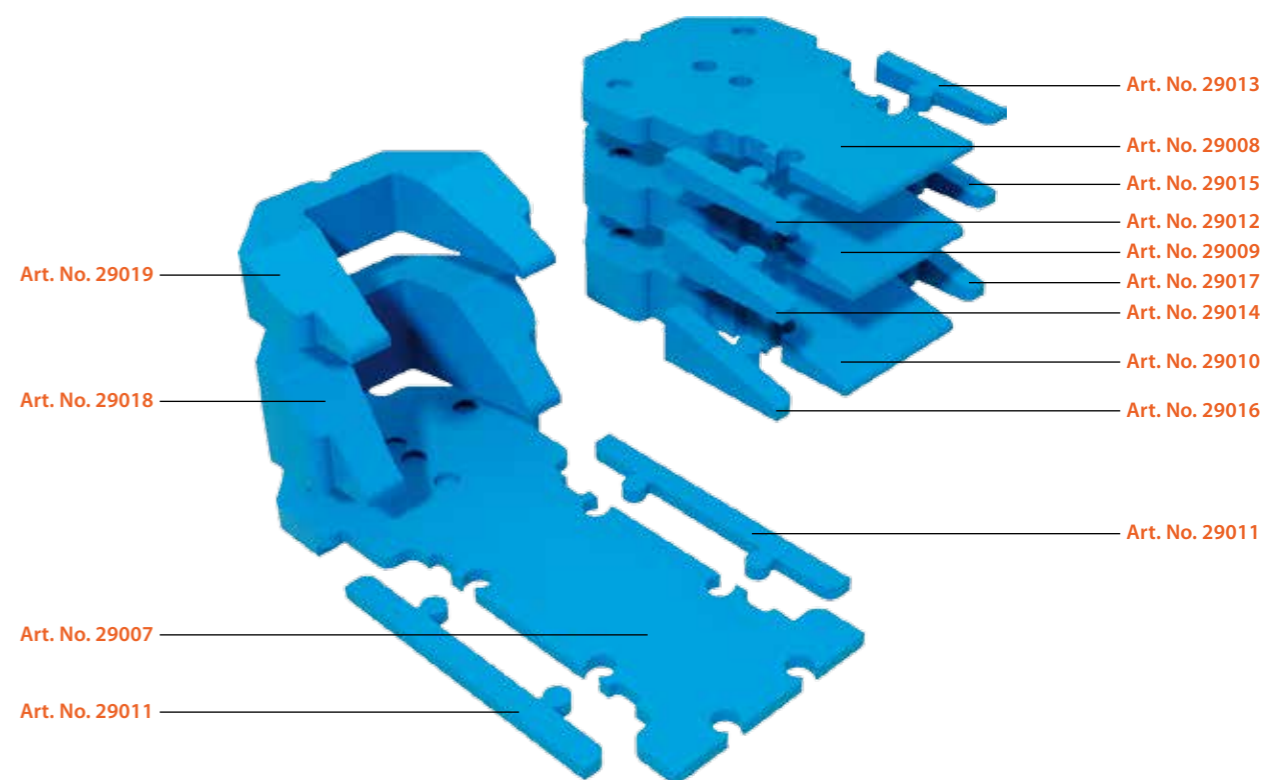

Cushions

Art. No.	AIO ID	
29008	TA-WE-5	Wedge 5°
29012	TA-LS-5	Lateral support - 5° (left)
29013	TA-LS-5	Lateral support - 5° (right)
29009	TA-WE-10	Wedge 10°
29014	TA-LS-10	Lateral support - 10° (left)
29015	TA-LS-10	Lateral support - 10° (right)
29010	TA-WE-15	Wedge 15°
29016	TA-LS-15	Lateral support - 15° (left)
29017	TA-LS-15	Lateral support - 15° (right)
29019	TA-AR-L	Arm rest - low
29018	TA-AR-H	Arm rest - high
29007	TA-WE-0	Wedge 0°
29011	TA-LS-0	Lateral support - 0°

Accessories

Art. No.	AIO ID	
32140	P-SE-LD	Secondary base plate in CFL
32015/9	AC-GP	Grip pole system
32706-MD		Set head supports (3) regular density - without lateral neck flaps

AIO Prone Breastboard Solution

The yellow cushion set is designed to obtain a comfortable and reproducible patient position for the "prone breast" treatment technique. This technique keeps the ipsi-lateral breast away from the chest wall and the underlying tissues and reduces the lung, heart and contra-lateral breast tissue volume that is trapped in the treatment fields.

- > The support wedge on the tunnel plate helps in limiting the volume of the sternum and contra-lateral breast tissue that will be caught in the radiation fields.
- > The use of the elevation cushion increases the total height of the set to 23 cm which allows the treatment of very large pendulous breasts.
- > The slope in the head cushion allows the arms to drop and thereby reduce the tension in the shoulders during longer imaging and treatment sessions to increase the patient's comfort.
- > The head can be positioned by means of two types of head supports:
 - A soft head support in the form of a ring that allows for a comfortable positioning of the head in prone position or sideways.
 - A support that fixes the head rigidly in prone position. This support can be adjusted to fit the anatomy of the patient's face and allows the use of Efficast masks for added precision.
- > Lateral inserts in the cushions are used for large patients.
- > Specially developed Efficast masks increase the precision of the treatment. They effectively immobilize the patient in the treated areas by reducing translational and rotational movements.

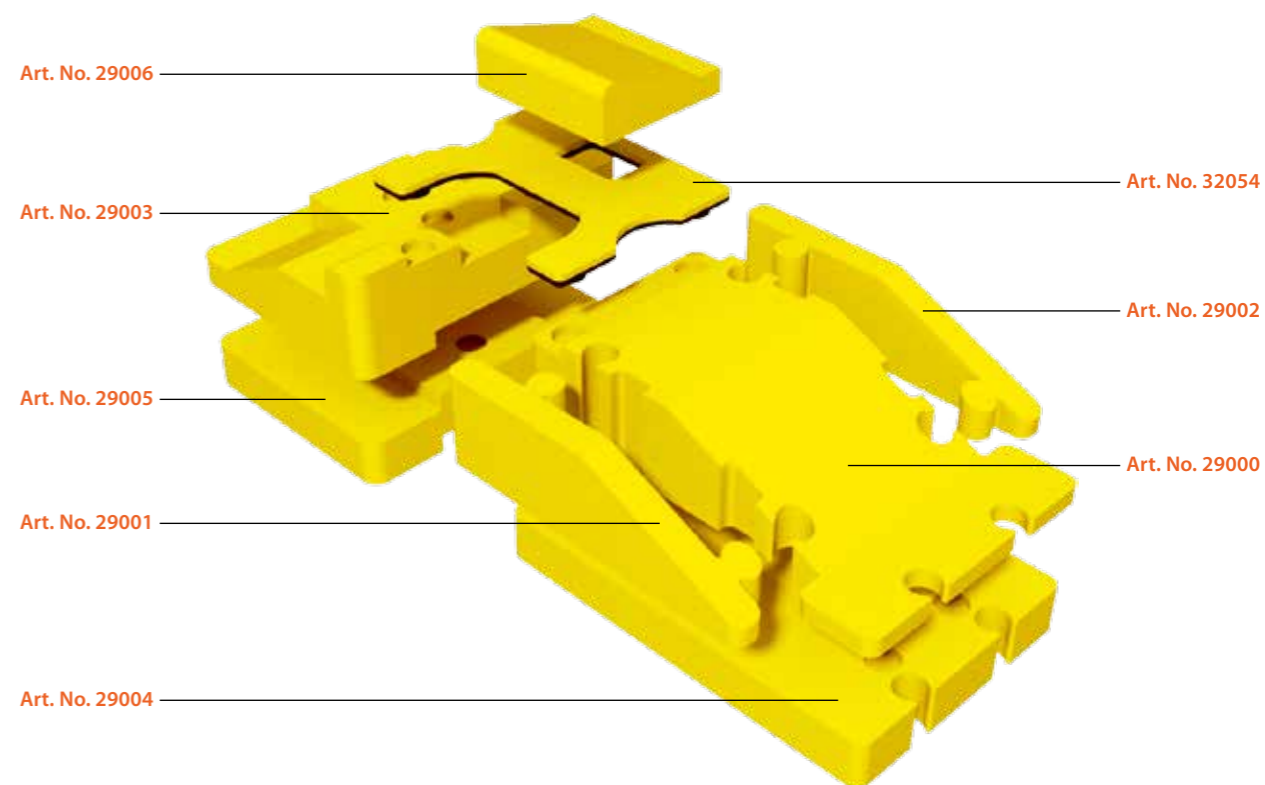
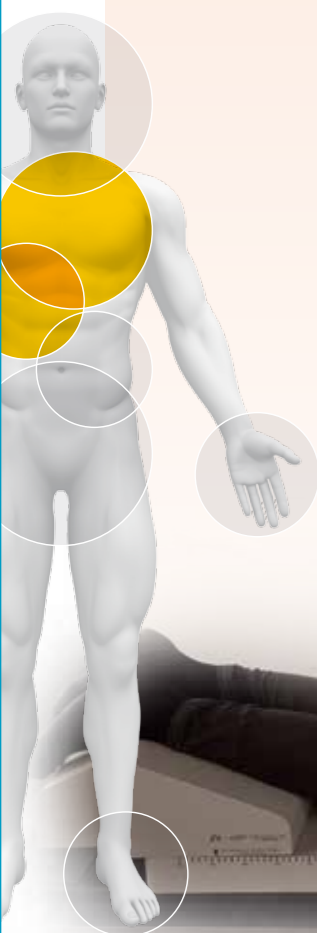

Cushions

Art. No.	AIO ID	
29006	BP-BW	Comfort wedge for contralateral side
32054	BP-SC	Support cushion for contralateral breast
29003	BP-HC-B	Cranial cushion - standard 15 cm clearance
29000	BP-CC-B	Caudal cushion - standard 15 cm clearance
29001	BP-LS	Lateral support (left)
29002	BP-LS	Lateral support (right)
29005	BP-HC-E	Cranial cushion - elevation to 23 cm clearance
29004	BP-CC-E	Caudal cushion - elevation to 23 cm clearance

Accessories

Art. No.	AIO ID	
29050	HS-PR-A	Prone head support
29051	HS-PR-M	Comfort prone head support
35754/1		PE block 20 mm
35754/2		PE block 40 mm

AIO Belly- and Pelvicboard Solution

The purpose of the belly board is to keep the intestines of the patient out of the radiation fields for treating malignancies in the pelvis area. The opening in the cushion is meant to accommodate the belly of the patient and thereby effectively separate the small bowels from the area to be treated.

- > The opening in the belly board can be fitted with three sizes of belly inserts for different sized patients. These inserts are made of a soft foam to increase comfort in the rib cage area.
- > Lateral inserts in the cushions allow the positioning of large patients.
- > The head part of the cushion is designed to drop the shoulders of the patient and reduce stress. The hands of the patient are placed under the base plate with the use of 2 hand grips.
- > The head can be positioned by means of two types of head supports:
 - A soft head support in the form of a ring that allows for a comfortable positioning of the head in prone position or sideways.
 - A support that fixes the head rigidly in prone position. This support can be adjusted to fit the anatomy of the patient's face and allows the use of Efficast masks for increased precision.
- > Pelvicast thermoplastic masks are used to reduce the cranial-caudal and rotational movements of the patients. A specially designed Leg Separator can be inserted after the patient has mounted the cushion, to fix a 6-points Pelvicast mask. This type of mask will further increase the reproducibility and precision of the treatment.

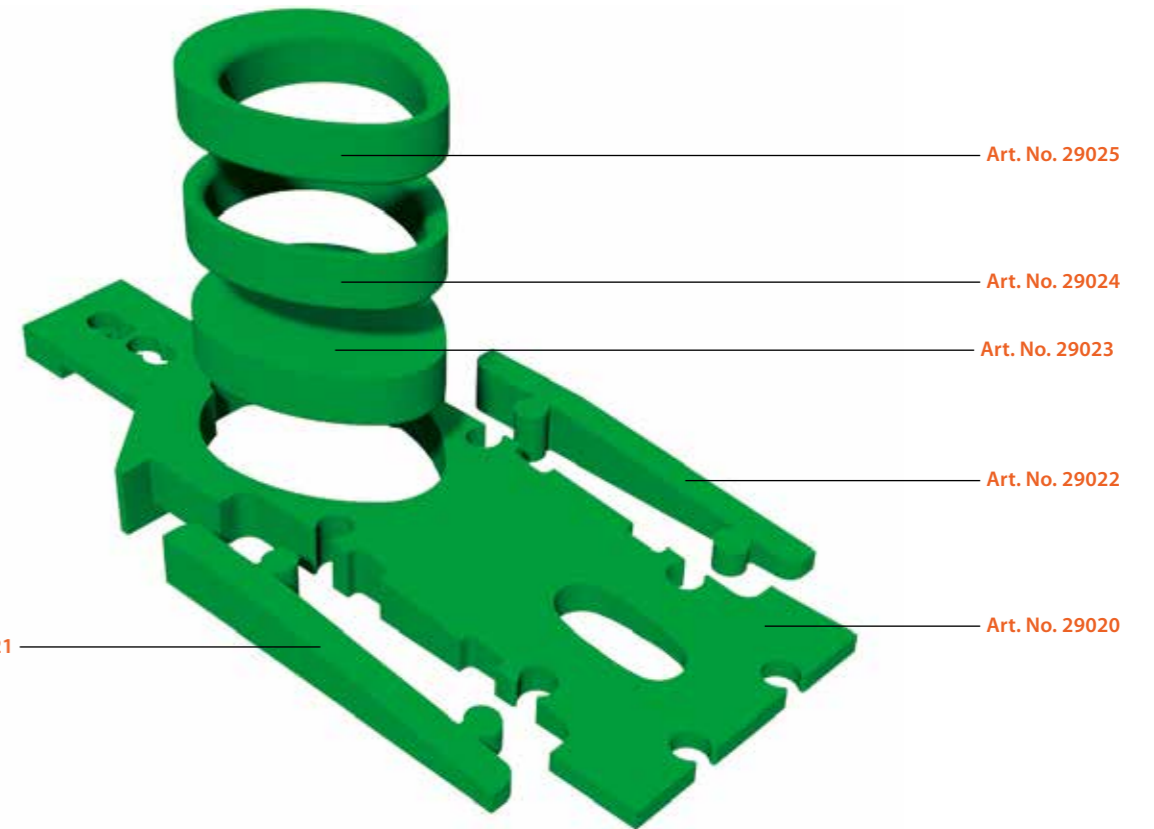

Art. No. 29021

Art. No. 29025

Art. No. 29024

Art. No. 29023

Art. No. 29022

Art. No. 29020

Cushions

Art. No.	AIO ID	
29025	BB-BI-2	Insert - small
29024	BB-BI-3	Insert - large
29023	BB-BI-1	Insert - full
29020	BB-BC	Belly & pelvic cushion
29021	BB-LS	Belly & pelvic lateral support (left)
29022	BB-LS	Belly & pelvic lateral support (right)

Accessories

Art. No.	AIO ID	
32015/8	AC-BG	Hand grips
32037	AC-LS	Leg separator
29051	HS-PR-M	Comfort prone head support
35754/1		PE block 20 mm
35754/2		PE block 40 mm
32706-MD		Set head supports (3) regular density without lateral neck flaps

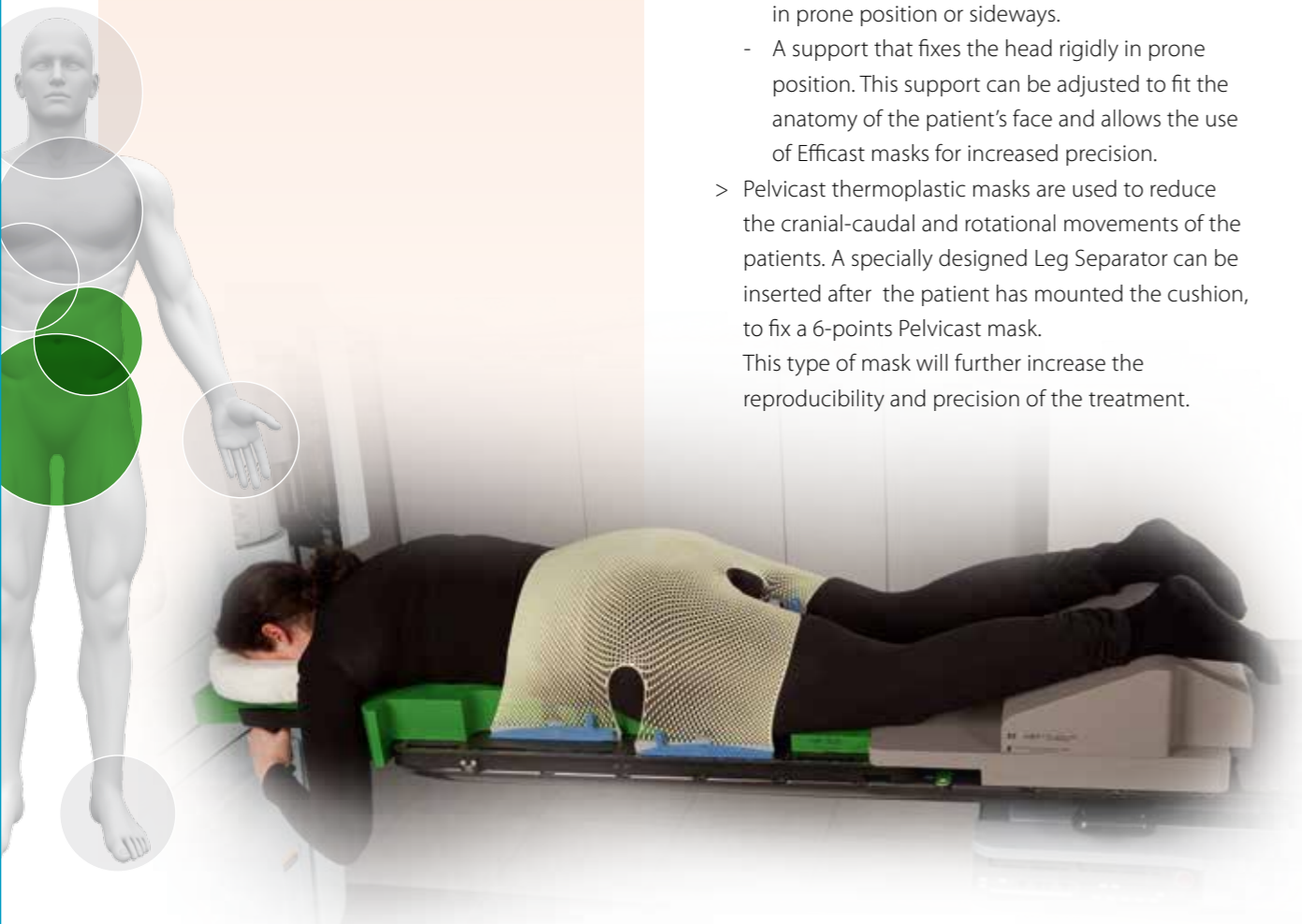

AIO Knee and Leg Positioning Set

An exact and comfortable position of the patient's legs is obtained by using the indexable knee and leg positioning set.

- > An elevated position of the legs reduces stress in the patient's back during the daily treatment fractions.
- > Can be used as a knee support in supine and as an ankle support in prone treatment position.
- > These cushions are also used as a reference point for setting up the other AIO Solution cushion sets.
- > The position of the cushion is easily reproduced by means of the millimetre scale and letter combinations.

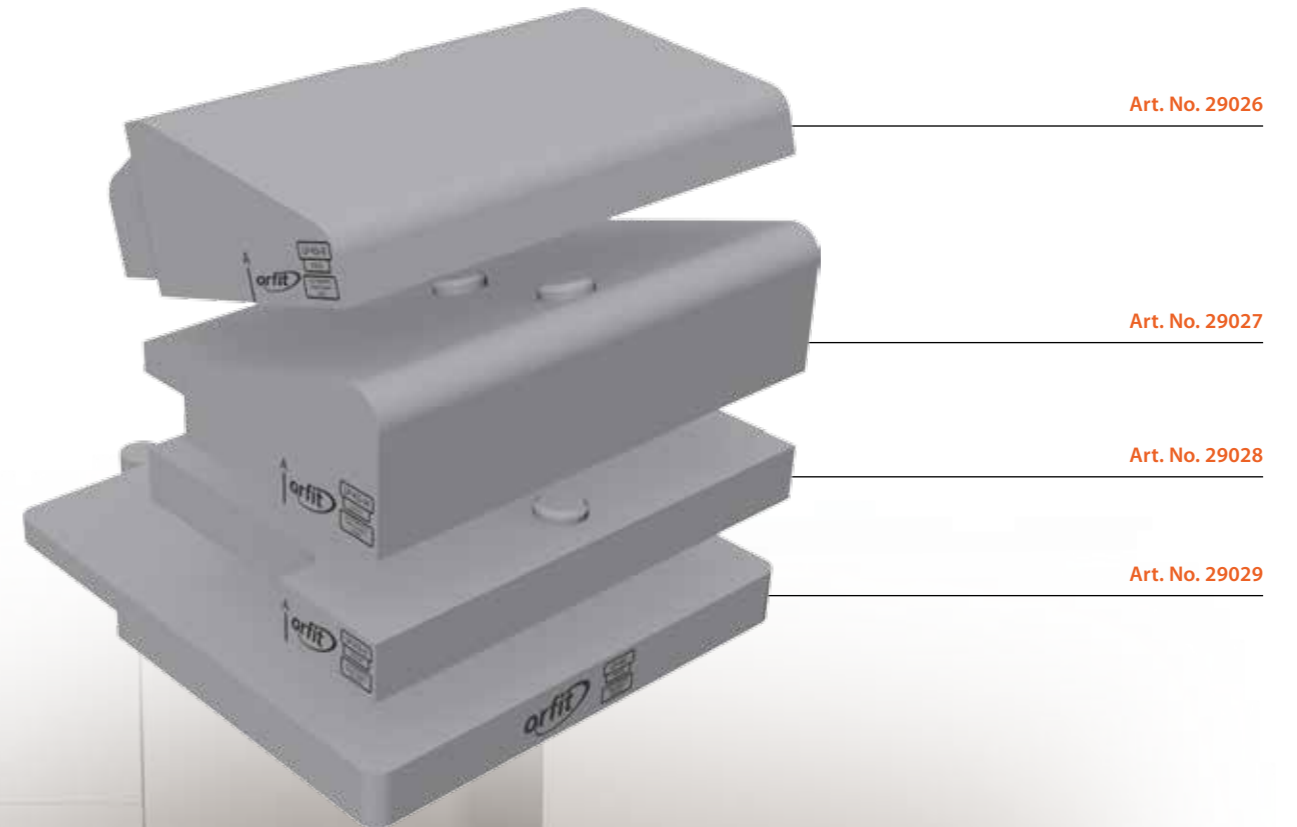

Art. No.	AIO ID	
29026	LP-KS-B	Basic low
29027	LP-KS-W	Wedge
29028	LP-KS-E	Elevation
29029	LP-EC	Base plate extension

The AIO Solution - Accessories

Thorax High Precision Pre-Cuts for the AIO Solution

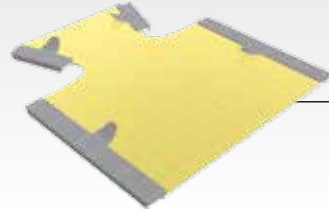

Art. No. 33715/2MA

4-points thorax supine mask - small

Art. No. 33716/2MA

4-points thorax supine mask - medium

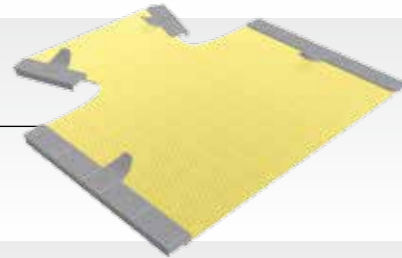

Art. No. 33717/2MA

4-points thorax supine mask - large

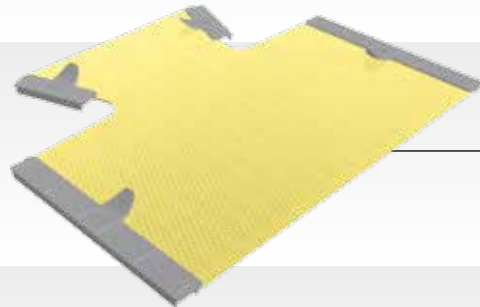

Art. No. 33775/2MI/12MI+N

4-points hybrid lung mask

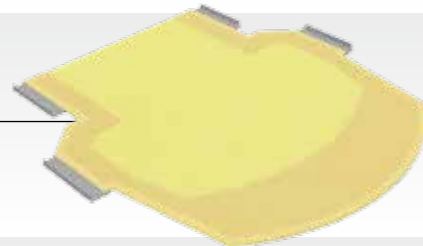

Art. No. 33723/32MA/L

5-points asymmetric breast mask supine - left

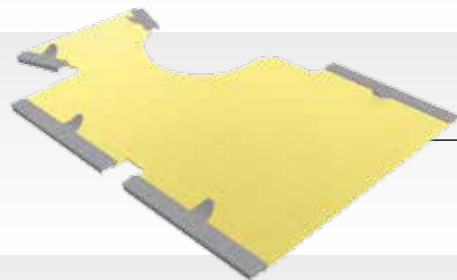

Art. No. 33723/32MA/R

5-points asymmetric breast mask supine - right

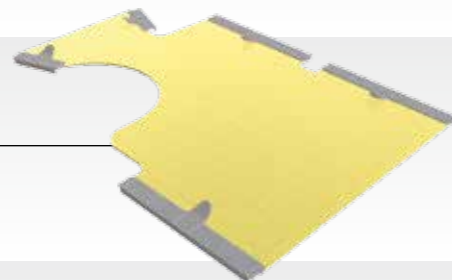

Art. No. 33724/32MA

6-points thorax and abdomen supine mask

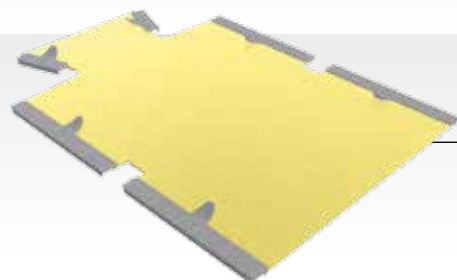

The AIO Solution - Accessories

Indexable Knee and Foot Solutions



Art. No. 29053

AIO indexable knee frame - short

Art. No. 29054

AIO indexable knee and foot frame

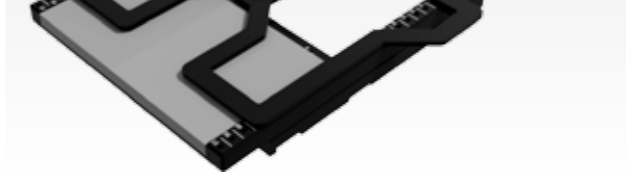
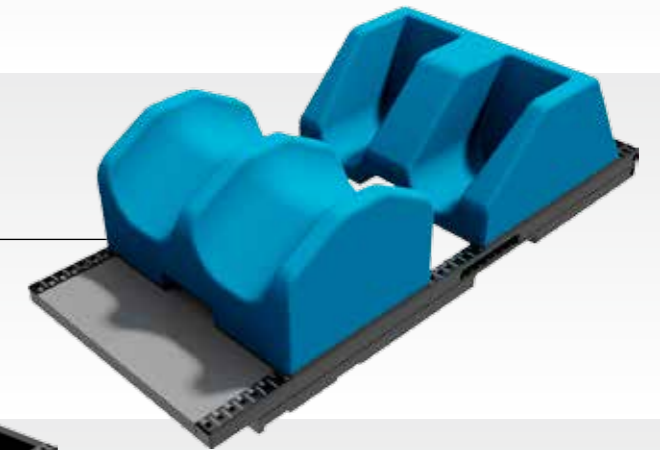

Art. No. 29055

AIO indexable knee frame - long

Positioning Plate



Art. No. 32291

Positioning plate for prone head support

